

10

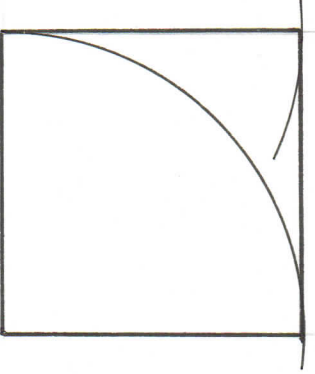

TRAZADOS GEOMÉTRICOS

TAREA 1

MARCO ARELLANO PERE 2

2º B

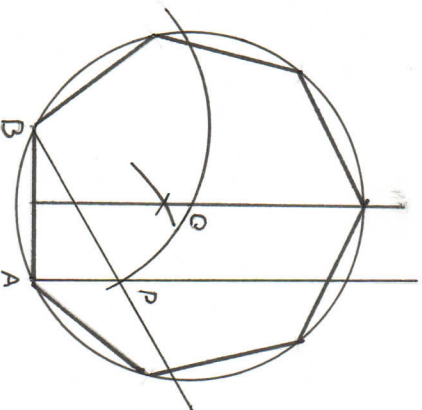

TRAZADO DE UNA RECTA TANGENTE A UNA CIRCUNFERENCIA

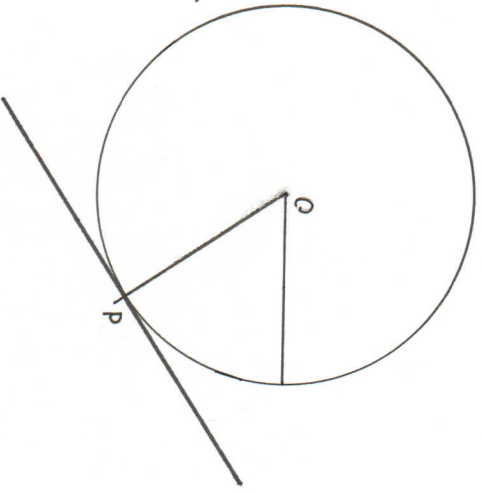

TRAZADO DE RECTAS TANGENTES EXTERIORES A DOS CIRCUNFERENCIAS

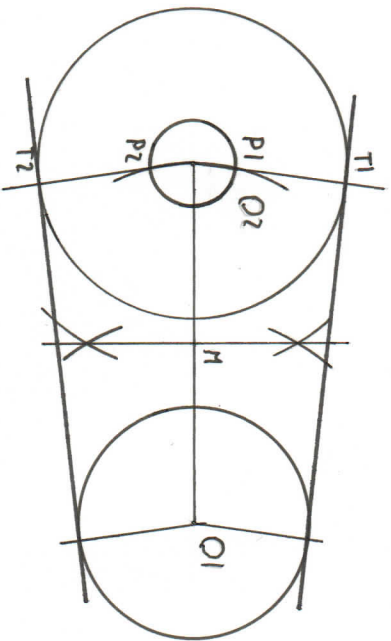

10

TRAZADO DE RECTAS TANGENTES A UNA CIRCUNFERENCIA DESDE UN PUNTO EXTERIOR A ELLA

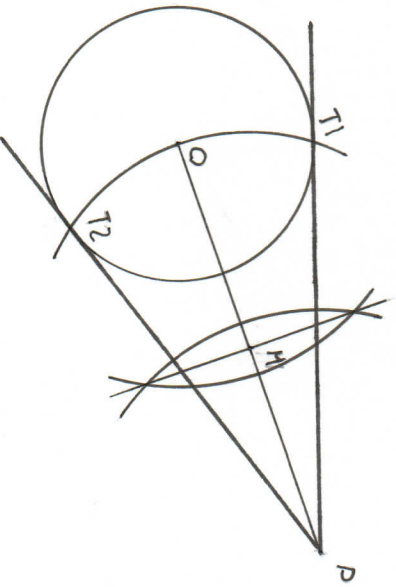

TRAZADO DE RECTAS TANGENTES INTERIORES A DOS CIRCUNFERENCIAS

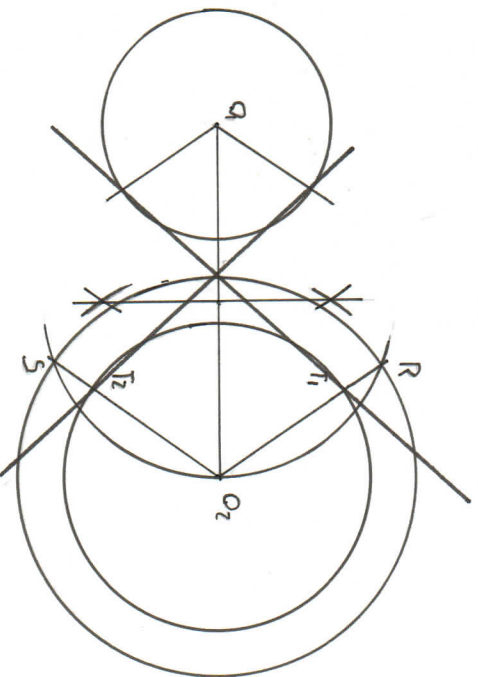

TANGENCIAS

TAREA 2

Marco Abelardo Pérez

2º B

TRAZADO DE UNA CIRCUNFERENCIA QUE PASE POR M Y SEA TANGENTE A R

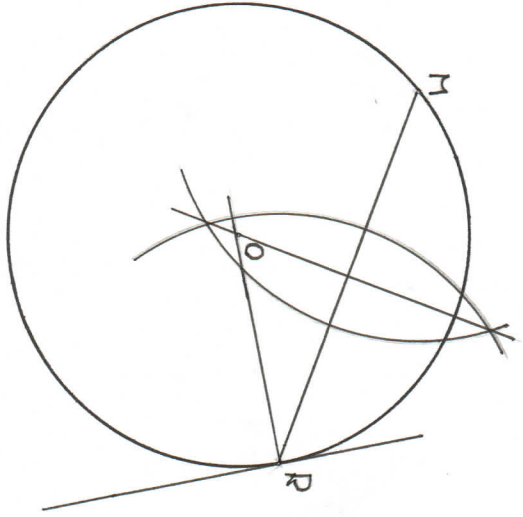

TRAZADO DE UNA ESPIRAL DE DOS CENTROS

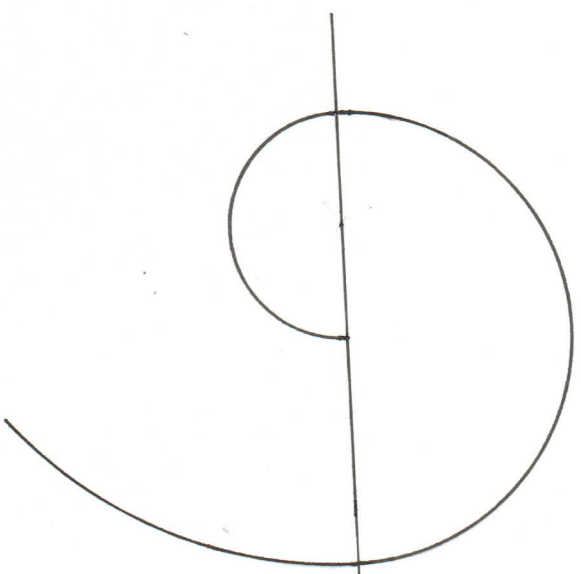

10

TRAZADO DE UNA CIRCUNFERENCIA DE RAYO R CONOCIDO TANGENTE A OTRA CIRCUNFERENCIA Y A UNA RECTA

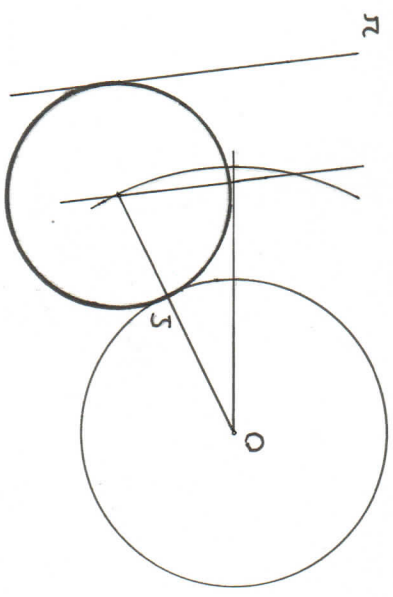

TRAZADO DE UNA ESPIRAL DE TRES CENTROS SITUADOS EN LOS VÉRTICES DE UN TRIÁNGULO

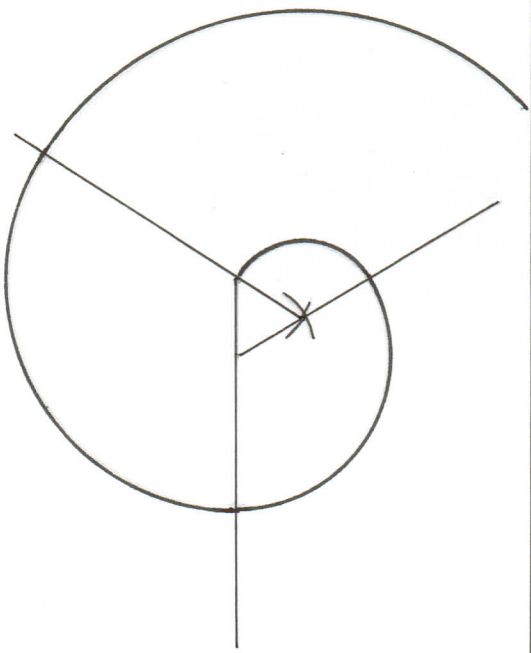

TANGENCIAS Y ESPIRALES

TAREA 3

MARCO ANECLANO PÉREZ

2º B

Fernand Macalino

Tarea 5

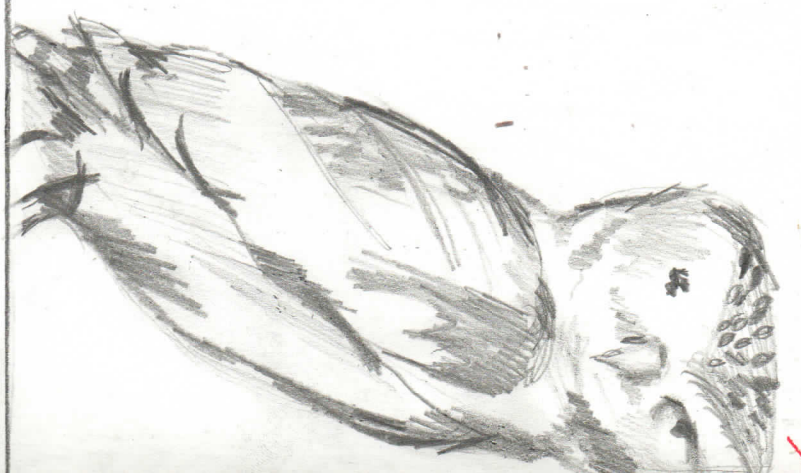
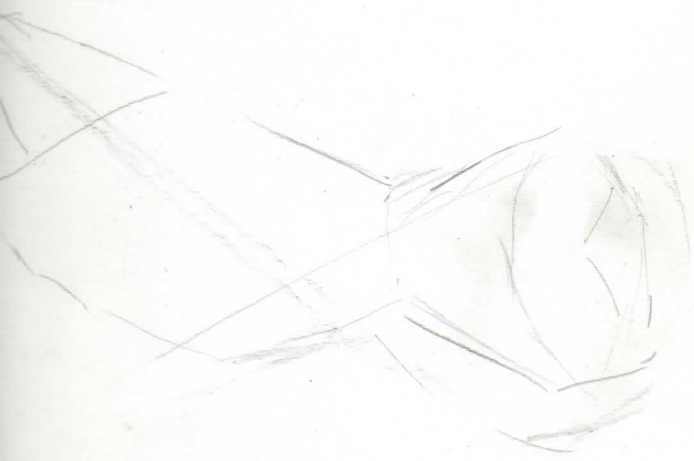

Handwritten red mark or signature.

Estructuras regulares

Tarea 6

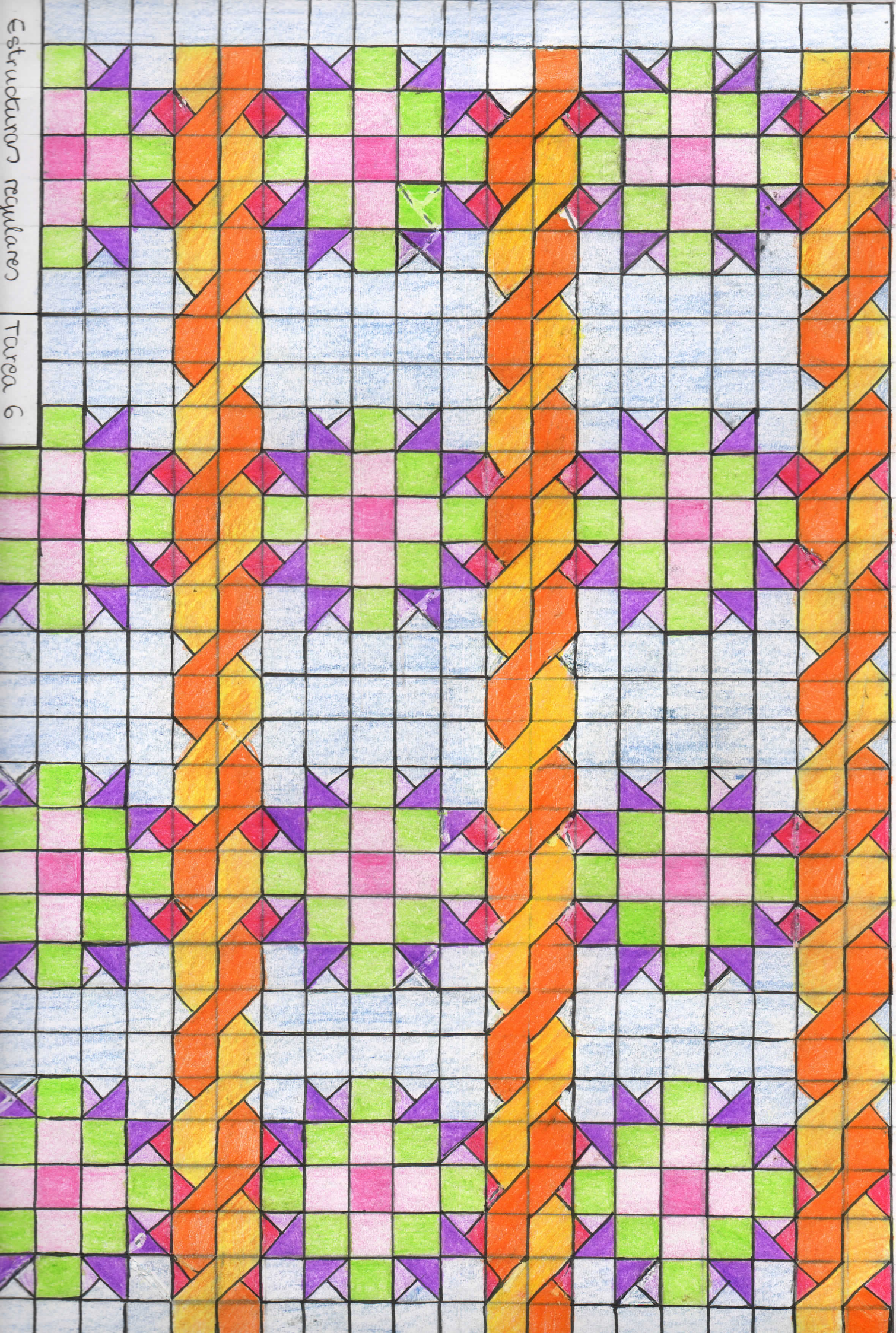

10

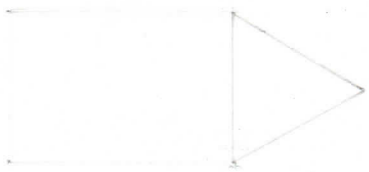

E = 1:1

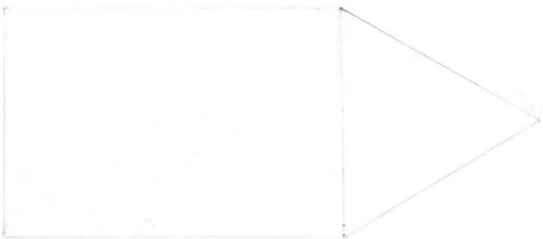

E = 3:2



Escuela, Proporciones y Similitud y Similitud

Tarea 7

Mane Antelano Peña

28/10/2013

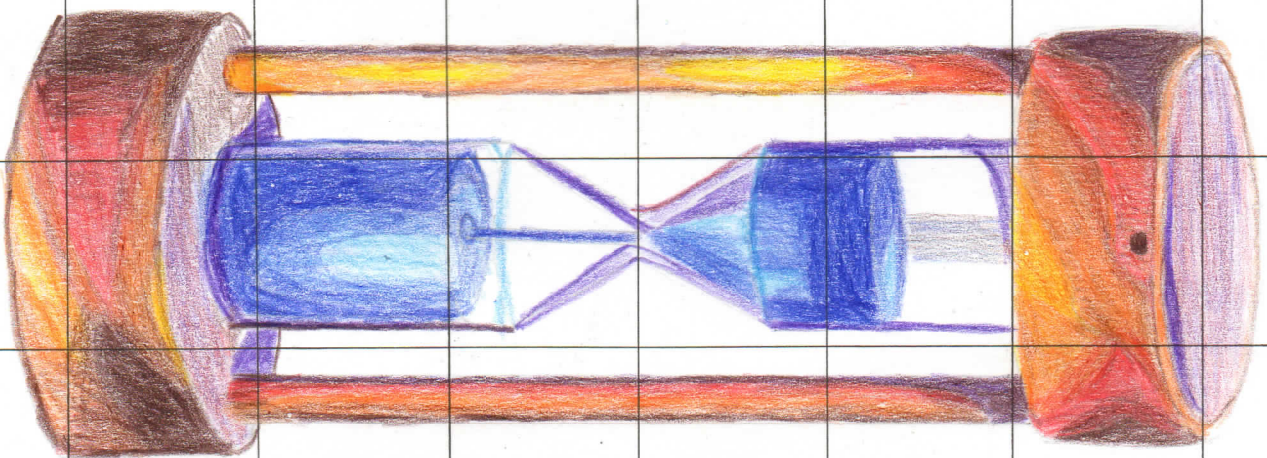

10

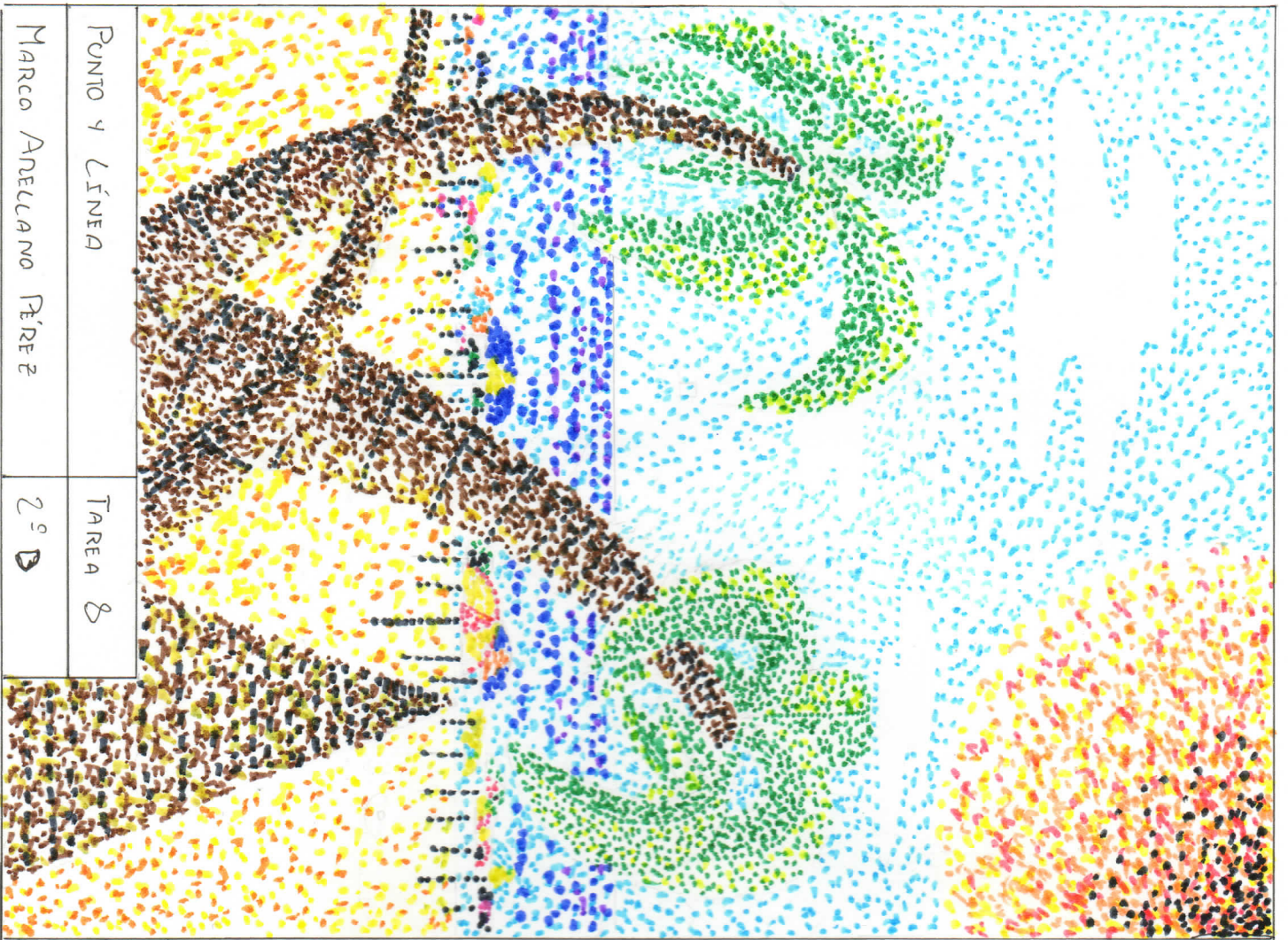

PUNTO Y LÍNEA

MARCO ANDELLANO PÉREZ

TAREA 8

2º B

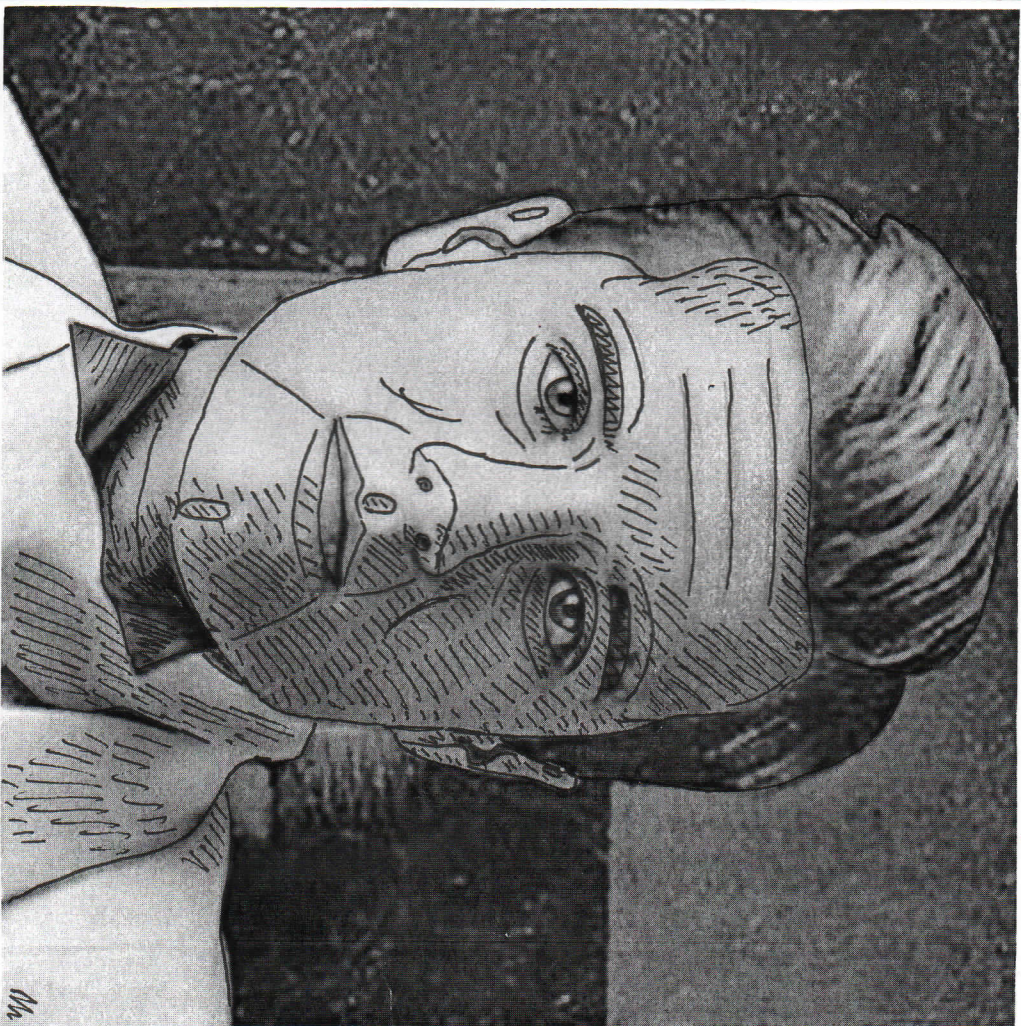

10

2

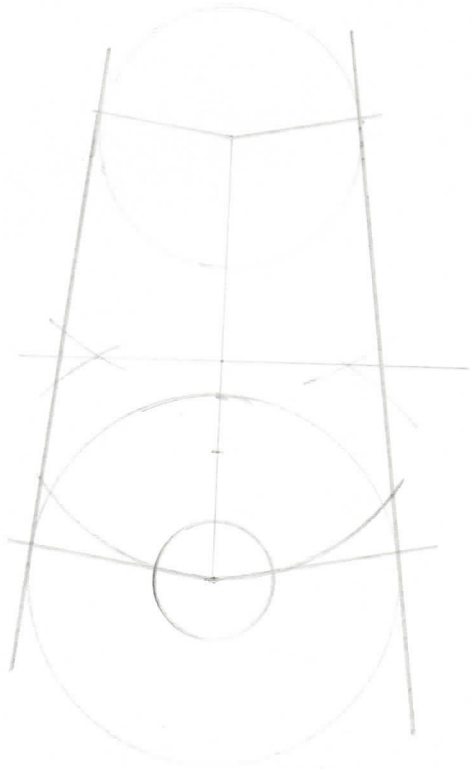

10

3

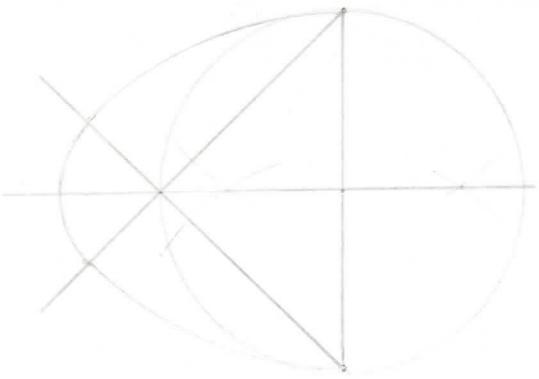

TAREA - 9 -

MARCO ARELLANO, RAFAEL

CONTROL

2º ESO B

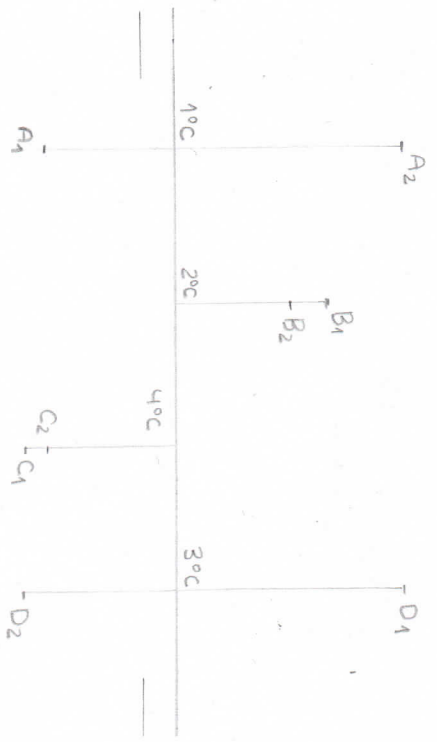

2'5

DIBUJA EN DIEDRICO UNA RECTA DADA POR LOS PUNTOS - A(4, 2, 4) B(4, 3, 3)

10

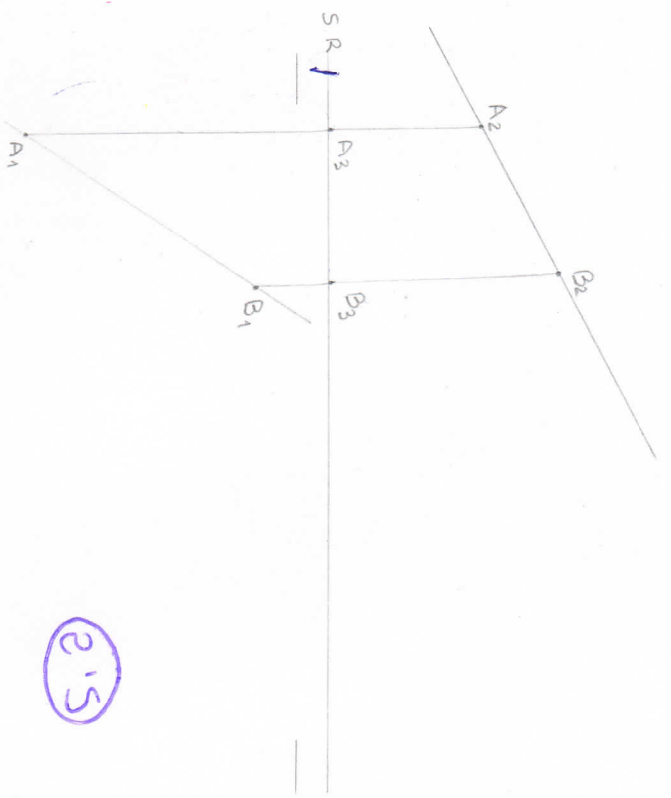

2'5

A(22, 0, 42)
B(22, 50, 17)

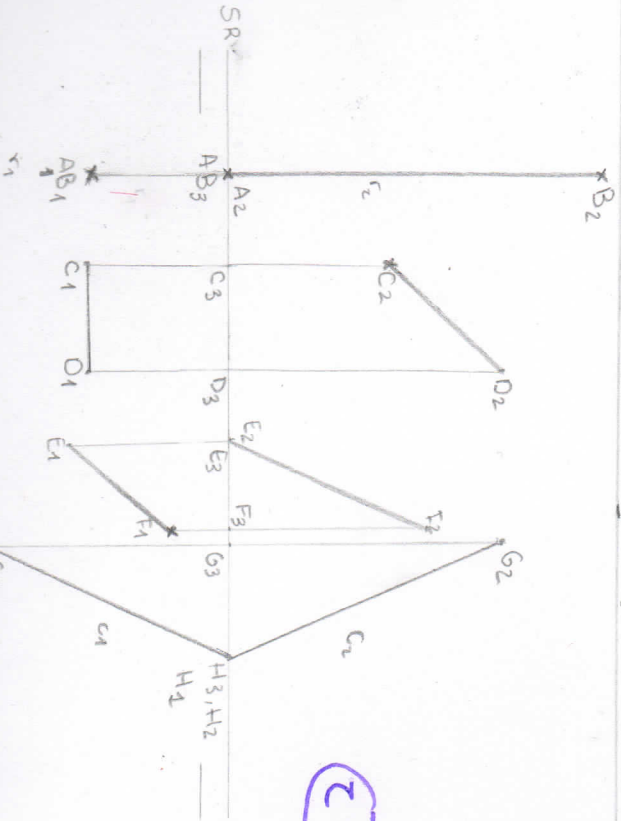

2'5

A(48, 0, 46)
B(48, 50, 46)
C(49, 24, 28)
D(49, 36, 42)

TAREA - 10

E(24, 0, 54)
F(8, 26, 63)
G(31, 36, 65)

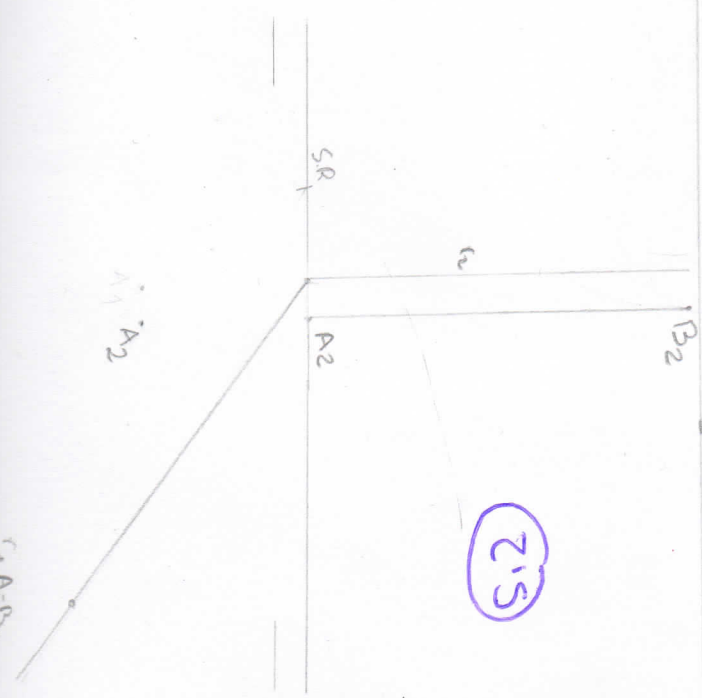

2'5

A1 A2
A1 A2

10

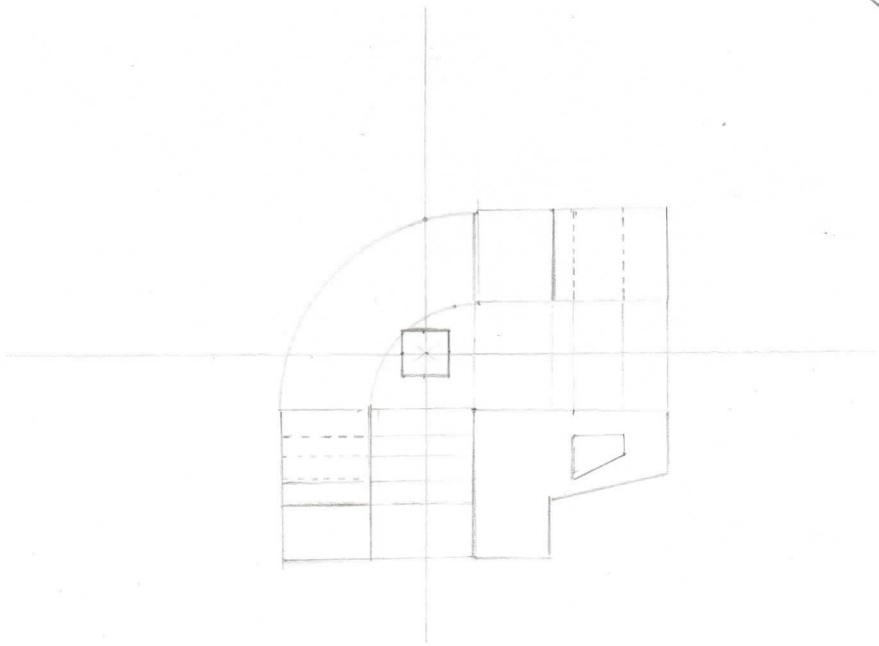
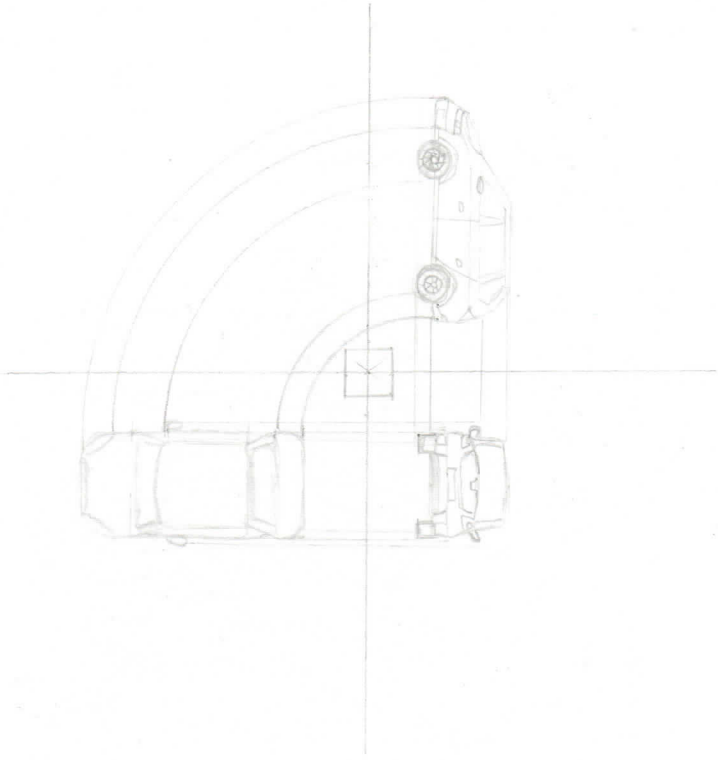

Sólidos en Dibujo

TAREA II

MARCO APOLLINO PÉREZ

2º B

Isométrica

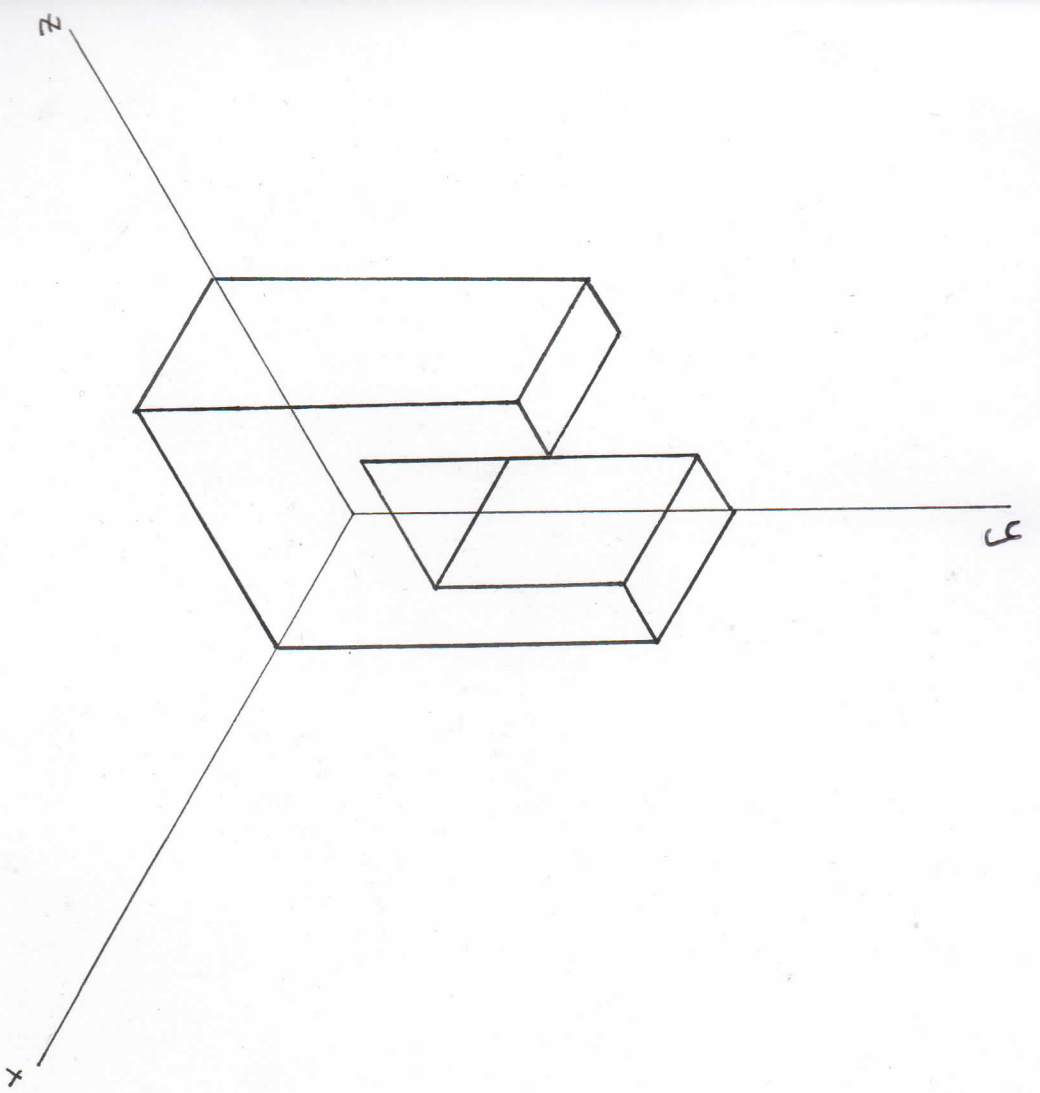

Caballera

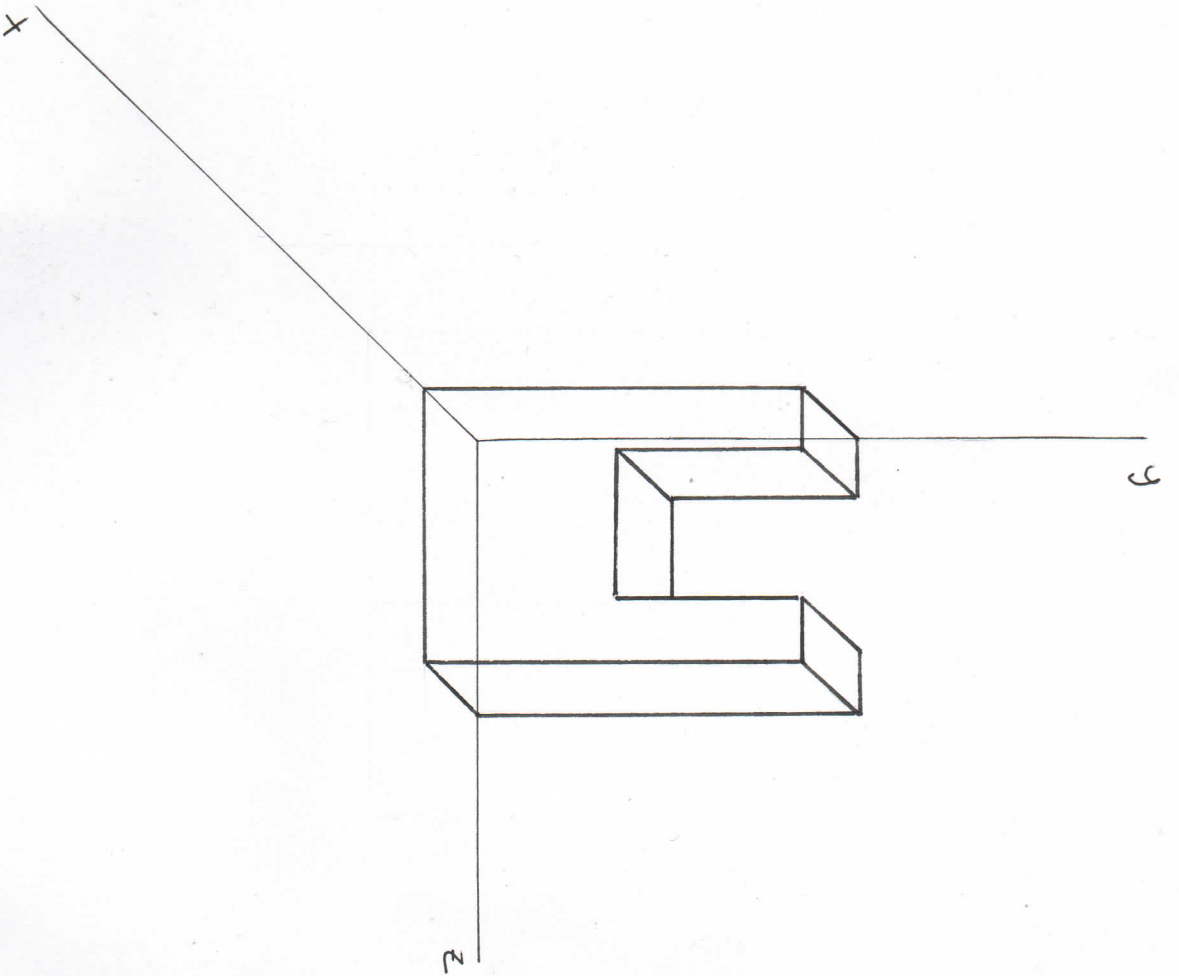

Isométrica y caballera

Tarea 12

18/02/15

Inene

Perspectiva cónica	Tarea 13
Irene Sierra Rodríguez	2º B

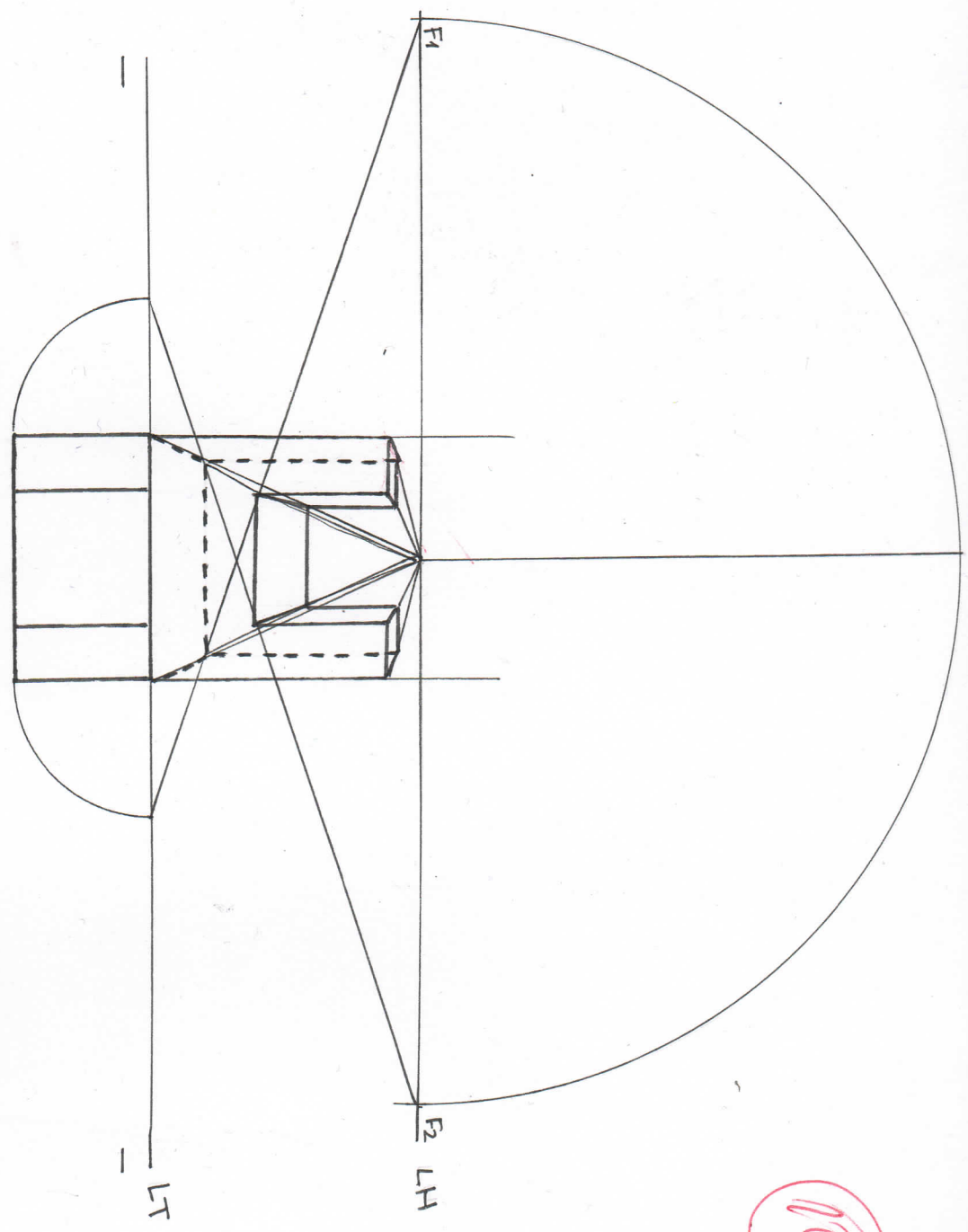

10

- TAREA 14:

RESUMEN DE LOS TEMAS DE
LA 2ª EVALUACIÓN

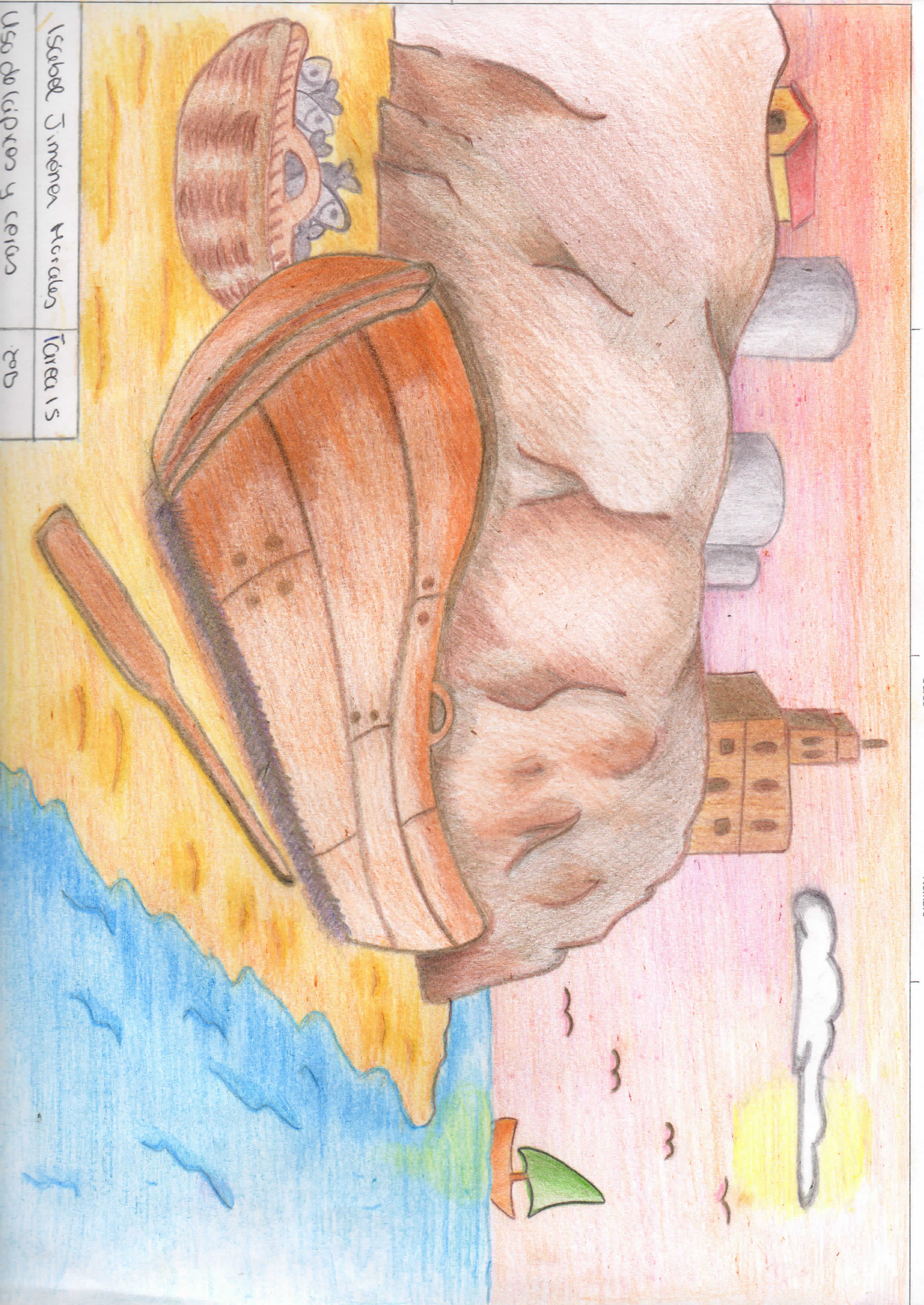

Isabel Jimena Arceles

Tarea 15

Uso del lápiz y ceras

200



q'25

28	Afana Devecchi? GroRa
Tema-5 16/17	Dagdas